

Specifications

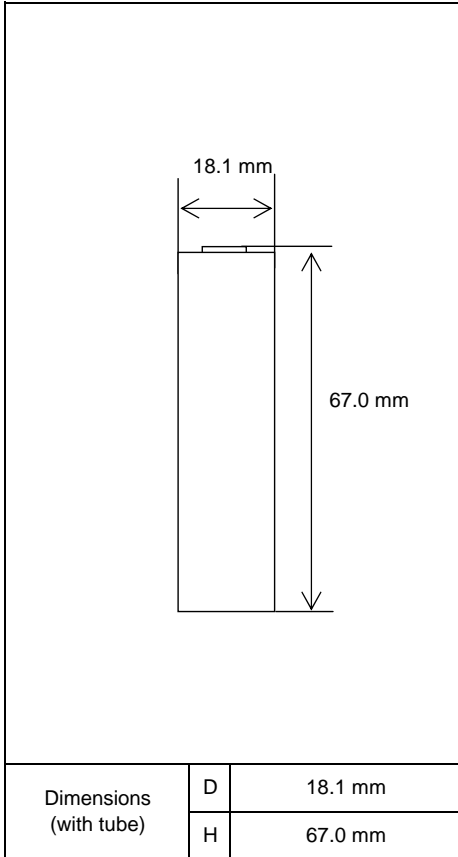

Type : Nickel-Metal Hydride Battery		Size : 4/3FA	
Capacity ¹⁾	Typical	3600mAh	
	Minimum	3400mAh	
Nominal Voltage		1.2V	
Charging Current x Time	Fast Charge ²⁾	3600 mA x about 1.1h	
Ambient Temp.	Charge Condition	Fast Charge ²⁾	
	Discharge Condition		
	Storage Condition	Less than 30days	0°C - 50°C
		Less than 90days	-20°C - 50°C
Less than 1year		-20°C - 40°C	
Internal Impedance ³⁾ (after discharge to E.V.=1.0V)		Approx. 7 mΩ(at 1000Hz)	
Weight ⁴⁾		Approx. 59 g	
Size ⁴⁾ : (Diameter) x (Height)		18.1(D) x 67.0(H) mm	

- 1) Single cell capacity under the following condition.
Charge : 360mA x 16h, Discharge : 720mA (E.V.=1.0V) at 20°C
- 2) Use recommended charging system.
- 3) After a few charge and discharge cycles under the above 1) condition.
- 4) With tube.

Typical Characteristics

Charge

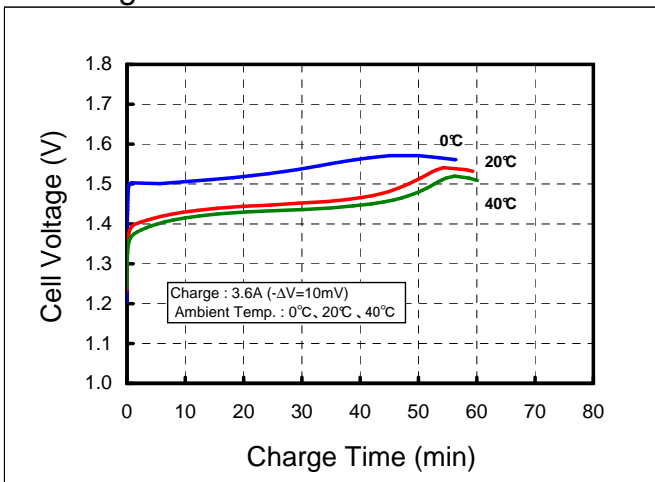

Discharge

