

# T ECHNICAL INFORMATION



PRODUCT  
P 1 / 5

Models No. ► DC18RC

Description ► Charger

## CONCEPT AND MAIN APPLICATIONS

Model DC18RC is a new developed compact size fast charger with the equivalent functions as current model DC18RA.

Its brief benefits are:

- 1) Only 22 minutes to fully charge of 3.0Ah Li-ion battery
- 2) Innovative computer controlled charging system provides optimum charge to each battery through the digital communication between charger and battery
- 3) Cooling fan to keep the battery temperature low for minimum charging time
- 4) The adapter ADP04 (optional accessory) enables to charge the existing Ni-Cd and Ni-MH batteries
- 5) The adapter ADP03 (optional accessory) enables to refresh inactive batteries
- 6) Selectable melody sound of completed charging

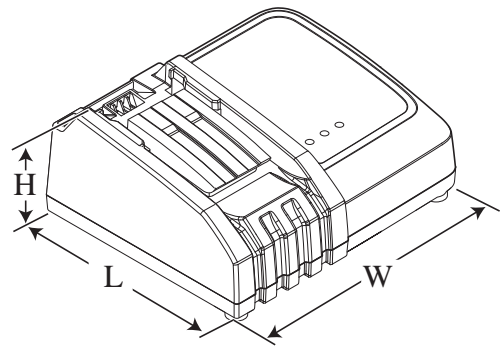

Dimensions: mm (")	
Length (L)	156 (6-1/8)
Width (W)	190 (7-1/2)
Height (H)	84 (3-5/16)

## ► Specification

Voltage (V)	Current (A)	Cycle (Hz)	Continuous Rating (W)		Standby power (W)
			Input	Output	
110-120		50/60	240		0.4
220-240		50/60	240		0.8

Output voltage: V	DC 7.2 - 18
Output current: A	DC 9.0
Protection against electric shock	Double insulation*1
Power supply cord: m (ft)	2.0 (6.5)
Weight according to EPTA-Procedure 01/2003: kg (lbs)	0.75 (1.65)

Charging time	Cell	Capacity:Ah	Voltage:V	Battery
Approx. 15 min.	Li-ion	1.3	14.4	BL1415
			18	BL1815
	Ni-MH	2.0	12	BH1220, BH1222C
			14.4	BH1420
Approx. 20 min.	Ni-MH	2.0	9.6	BH9020, BH9020A
		2.7	14.4	BH1427
Approx. 22 min.	Li-ion	3.0	14.4	BL1430, BL1430A
			18	BL1830
	Ni-MH	3.3	12	BH1233, BH1233C
Approx. 30 min.	Ni-MH	3.3	14.4	BH1433
			9.6	BH9033, BH9033A
	Ni-Cd*2	1.3	7.2 - 18	All 1.3Ah Ni-Cd batteries except maktec series
Approx. 45 min.	Ni-Cd*2	2.0	7.2 - 18	All 2.0Ah Ni-Cd batteries
Approx. 60 min.	Ni-MH*2	2.6	7.2 - 18	All 2.6Ah Ni-MH stick/ pod batteries
Approx. 70 min.	Ni-MH*2	3.0	9.6 - 18	All 3.0Ah Ni-MH stick/ pod batteries

\*1: excludes some countries

\*2: use with interchangeable adapter ADP04 (optional accessory).

**Note:** The charging time depends to a large extent on battery's temperature or room temperature.

## ► Optional accessories

ADP03 Automatic Refreshing Adapter,  
ADP04 Interchangeable Adapter

## ▶ Repair

- CAUTION:**
- Repair the machine in accordance with “Instruction manual” or “Safety instructions”.
  - Due to the difference of factories, the shapes and positions of actual parts are different from those shown in the following drawings.

### [1] DISASSEMBLING / ASSEMBLING

#### [1]-1. Charger case and Terminal unit

##### DISASSEMBLING

Remove Charger case and Terminal unit as drawn in **Fig. 1**.

**Fig. 1**

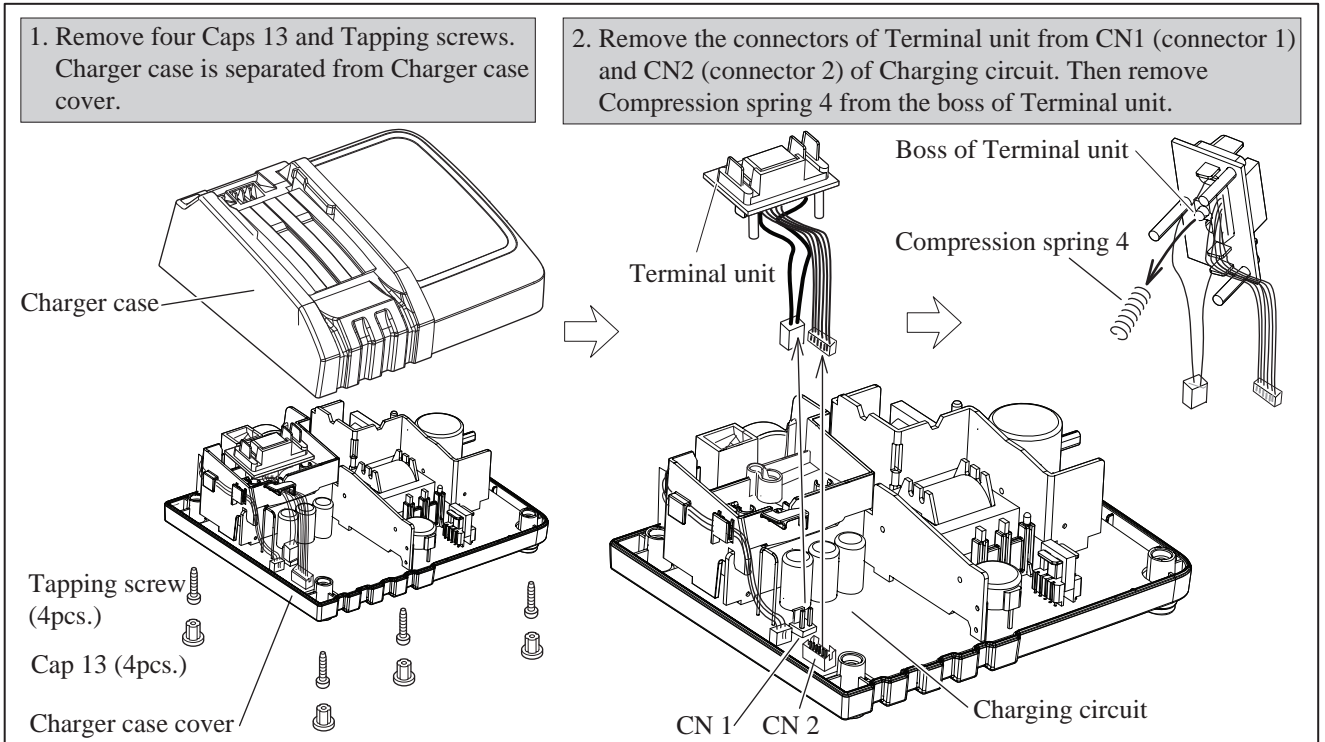

##### ASSEMBLING

- (1) Set Compression spring 4 to Terminal unit. Refer to **Fig. 1**.
- (2) Assemble Terminal unit as drawn in **Fig. 2**.
- (3) Assemble Charger case to Charger case cover by fastening four Tapping screws. Do not pinch the lead wires.
- (4) Insert four Caps 13 into the holes of Charger case cover.

**Fig. 2**

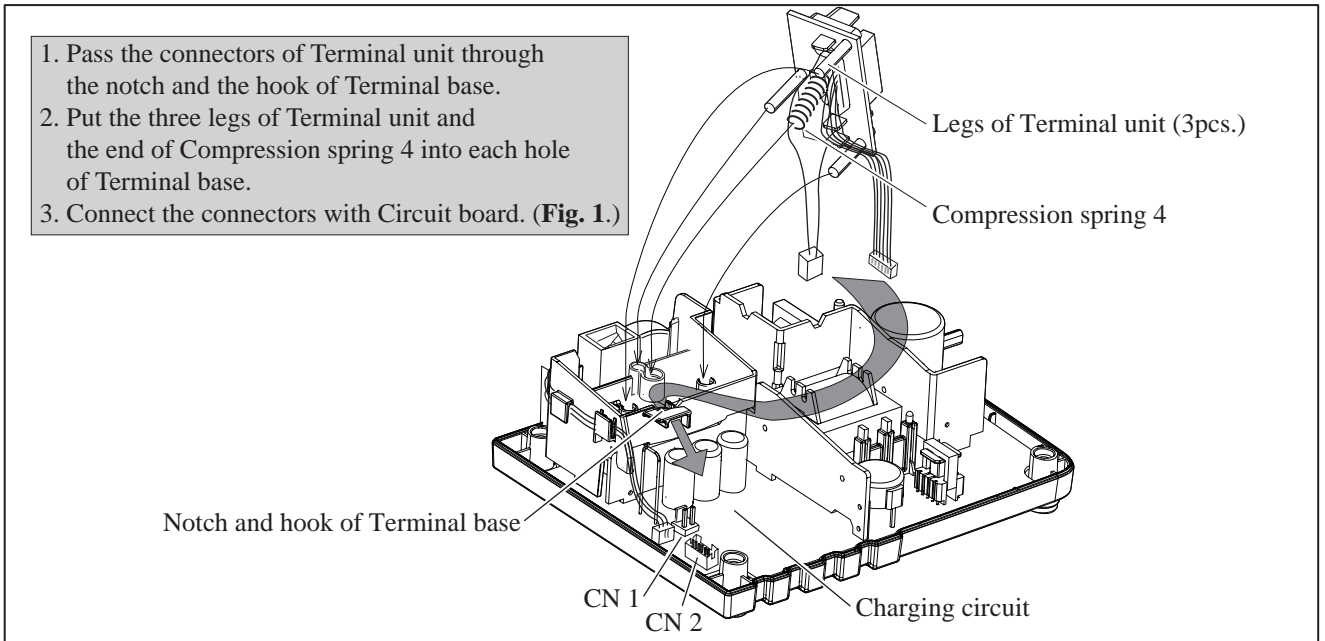

► **Repair**

[1] **DISASSEMBLING / ASSEMBLING**

[1]-2. **Terminal cover**

DISASSEMBLING

Remove 3x10 Tapping screw from the reverse side of the removed Charger case complete, then separate a couple of Compression spring 4 from Terminal cover.

**Note:** These compression springs are different from Compression spring 4 behind Terminal unit.

Fig. 3

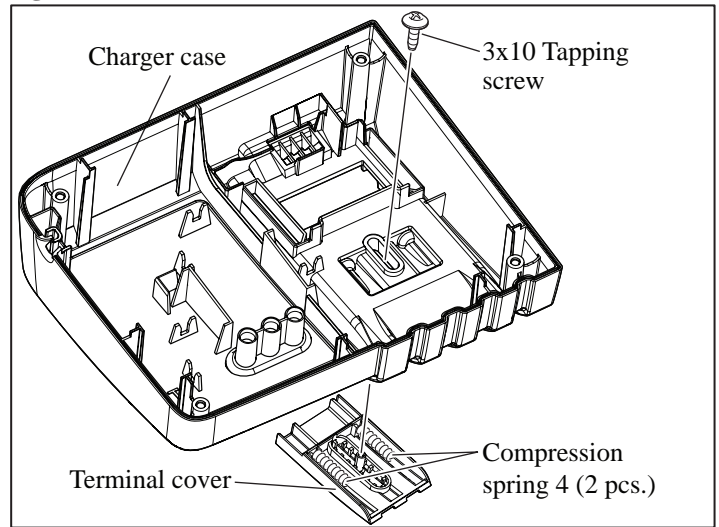

ASSEMBLING

Refer to Fig. 4.

Fig. 4

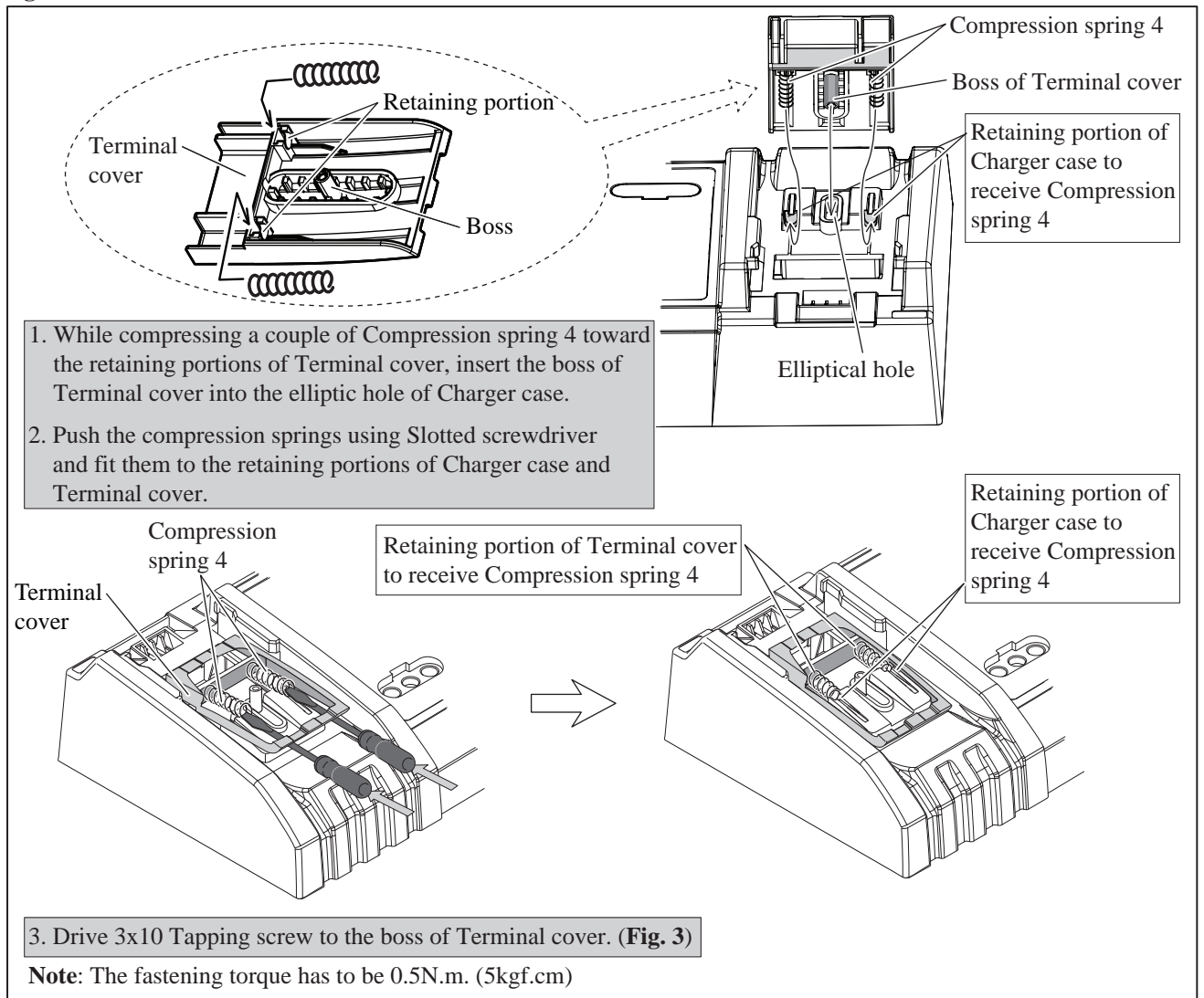

► **Repair**

**[1] DISASSEMBLING / ASSEMBLING**

**[1]-3 Wiring of Power supply cord and Lead wires of Scirocco fan**

Be careful to route Power supply cord and Lead wires of Scirocco fan into Charger case cover as drawn in **Fig. 5**.

**Fig. 5**

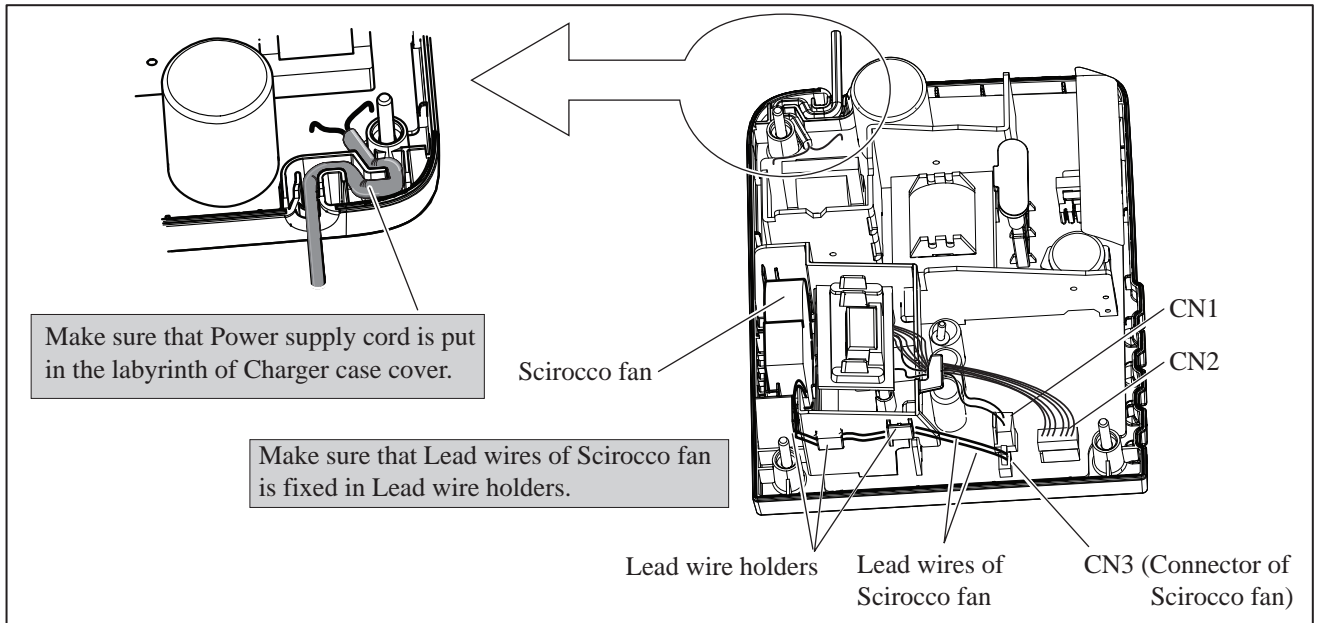

**[1] -4. Terminal base, Circuit board**

**DISASSEMBLING**

Remove Terminal base and Circuit board in accordance with [1]-1 and **Fig. 6**.

**Fig. 6**

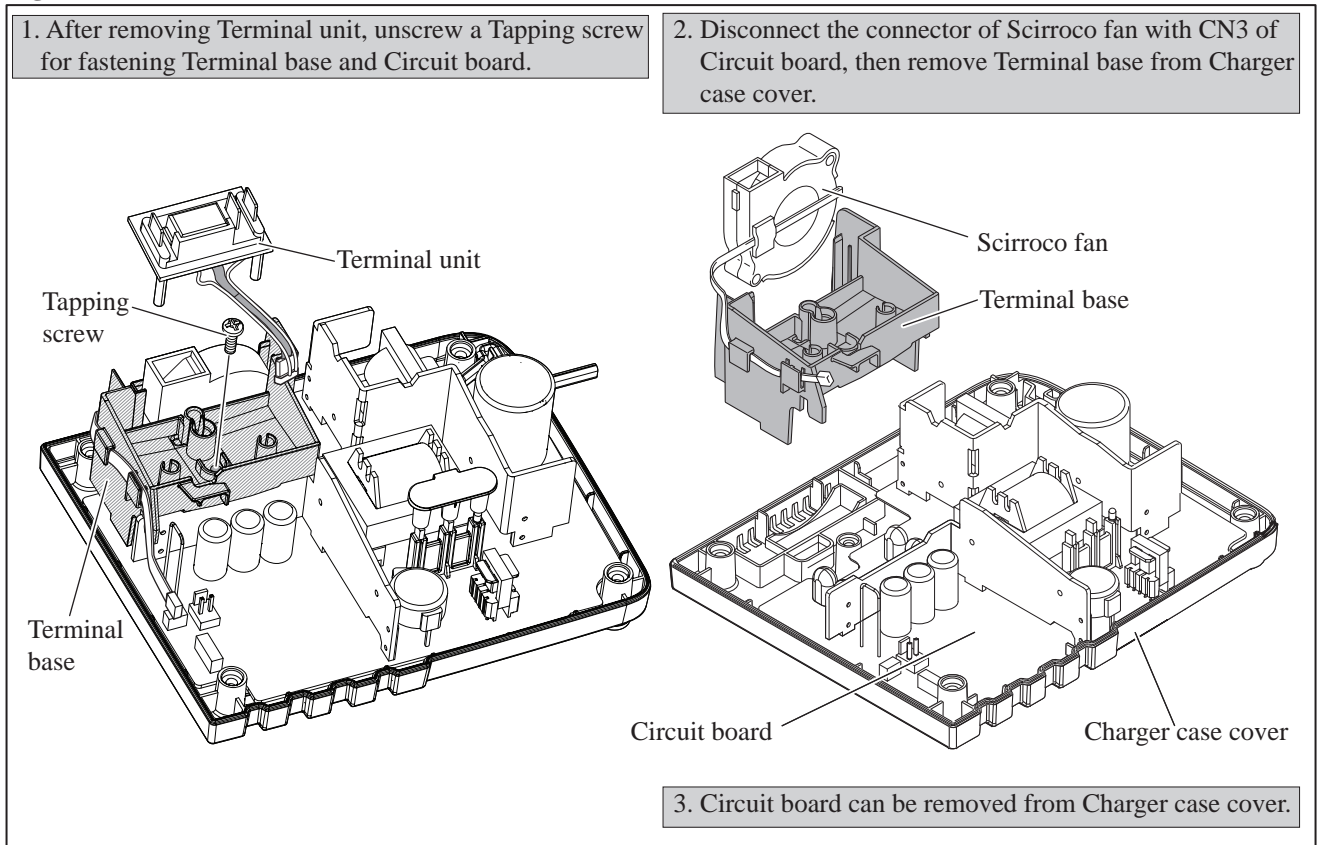

**ASSEMBLING**

Take the reverse step of Disassembling.

## ► Repair

### [1] DISASSEMBLING / ASSEMBLING

#### [1] -5. Varistor and Fuse

##### (1) Types of Breakage

1. If Fuse is broken, Varistor is usually broken by showing the sign of breakage mentioned below.  
In this case, replace fuse and varistor at the same time.

##### Sign of varistor breakage

- a) Cracks in the surface of varistor
  - b) Black discolored surface of varistor
2. Only Varistor can be damaged if Charger is plugged in a power source at double the rated voltage.  
In this case, replace Varistor solely.
  3. If Fuse is broken while Varistor is not broken, Circuit board can be broken.  
In this case, replace charging circuit complete. (**Fig. 6**)

##### (2) Replacing Varistor/ Fuse

Varistor/fuse is soldered on the Circuit board. Remove a broken Varistor / Fuse with soldering iron and solder brand-new one. (**Fig. 7**)

**Note:** Be sure to use the appropriate parts.

**Fig. 7**

